

Varenummer: 4320001201
Beskrivelse: Rota-fix spændelement A 120x165
Rustfast stål

Mål

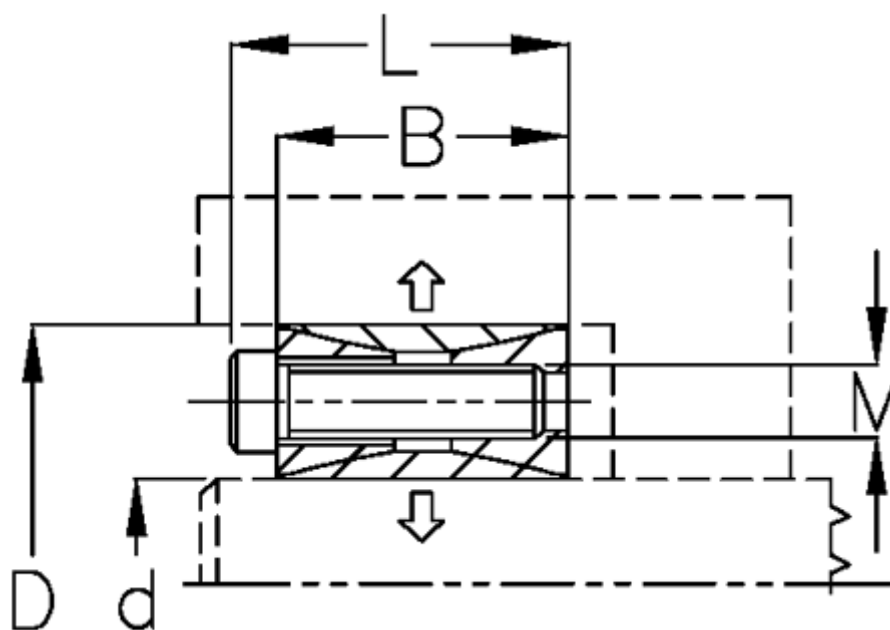

B mm	= 33
d H8 mm	= 120
D mm	= 165
F kN aksialkraft	= 132.0
L mm	= 45
M mm	= M12
Overfladeruhed	= R? ? 3.2 μ m
P N/mm ² fladetryk på aksel/nav	= 51

T Nm drejningsmoment	= 7900
Tolerance	= Aksel k11-h11, Nav M
Ts Nm boltetilspændingsmoment	= 74.0